

20V N-Channel Enhancement Mode MOSFET

Description

The NP2302FHR uses advanced trench technology to provide excellent $R_{DS(ON)}$, low gate charge and high density cell Design for ultra low on-resistance. This device is suitable for use as a load switch or in PWM applications.

General Features

- ◆ $V_{DS} = 20V$, $I_D = 3A$
 $R_{DS(ON)}(Typ.) = 45m\Omega$ @ $V_{GS} = 4.5V$
 $R_{DS(ON)}(Typ.) = 73m\Omega$ @ $V_{GS} = 2.5V$
- ◆ High power and current handling capability
- ◆ Lead free product is acquired
- ◆
- ◆ Surface mount package

Application

- ◆ PWM applications
- ◆ Load switch

Package

- ◆ ESOT-23-3L



Schematic diagram

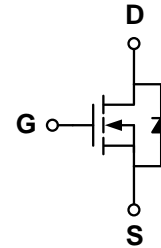

Marking and pin assignment

ESOT-23-3L
(TOP VIEW)

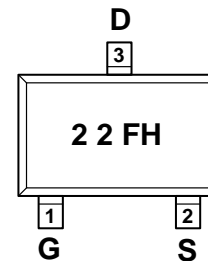

Ordering Information

Part Number	Storage Temperature	Package	Devices Per Reel
NP2302FHR-G	-55°C to +150°C	ESOT-23-3L	3000

Absolute Maximum Ratings (TA=25°C unless otherwise noted)

parameter	symbol	limit	unit
Drain-source voltage	V_{DS}	20	V
Gate-source voltage	V_{GS}	±12	V
Drain current-continuous ^a @Tj=125°C -pulse ^b	I_D	3	A
	I_{DM}	12	A
Drain-source Diode forward current	I_S	1.6	A
Maximum power dissipation	P_D	1.5	W
Operating junction Temperature range	T_j	-55—150	°C

Electrical Characteristics (TA=25°C unless otherwise noted)

Parameter	Symbol	Condition	Min	Typ	Max	Unit
OFF Characteristics						
Drain-source breakdown voltage	BV_{DSS}	$V_{GS}=0V, I_D=250\mu A$	20	-	-	V
Zero gate voltage drain current	I_{DSS}	$V_{DS}=20V, V_{GS}=0V$	-	-	1	μA
Gate-body leakage	I_{GSS}	$V_{DS}=0V, V_{GS}=\pm 12V$	-	-	± 100	nA
ON Characteristics						
Gate threshold voltage	$V_{GS(th)}$	$V_{DS}=V_{GS}, I_D=250\mu A$	0.5	0.75	1.2	V
Drain-source on-state resistance	$R_{DS(ON)}$	$V_{GS}=4.5V, I_D=3A$	-	45	66	m Ω
		$V_{GS}=2.5V, I_D=3A$		73	102	
Forward transconductance	g_{fs}	$V_{GS}=5V, I_D=3A$	-	11	-	S
Dynamic Characteristics						
Input capacitance	C_{ISS}	$V_{DS}=10V, V_{GS}=0V$ $f=1.0MHz$	-	145	-	pF
Output capacitance	C_{OSS}		-	26	-	
Reverse transfer capacitance	C_{RSS}		-	22	-	
Switching Characteristics						
Turn-on delay time	$t_{D(ON)}$	$V_{DD}=10V$ $R_L=3.3\ ohm$ $V_{GEN}=4.5V$ $R_{GEN}=6ohm$	-	2.3	-	ns
Rise time	t_r		-	3.1	-	
Turn-off delay time	$t_{D(OFF)}$		-	21	-	
Fall time	t_f		-	2.6	-	
Total gate charge	Q_g	$V_{DS}=10V$ $I_D=3A$ $V_{GS}=4.5V$	-	4.8	-	nC
Gate-source charge	Q_{gs}		-	0.3	-	
Gate-drain charge	Q_{gd}		-	0.6	-	
DRAIN-SOURCE DIODE CHARACTERISTICS						
Diode forward voltage	V_{SD}	$V_{GS}=0V, I_S=3A$	-	0.76	1.16	V

Notes:

- surface mounted on FR4 board, $t \leq 10sec$
- pulse test: pulse width $\leq 300\mu s$, duty $\leq 2\%$
- guaranteed by design, not subject to production testing

Thermal Characteristics

Thermal Resistance junction-to ambient	$R_{th\ JA}$	100	$^{\circ}C/W$
----------------------------------------	--------------	-----	---------------

Typical Performance Characteristics

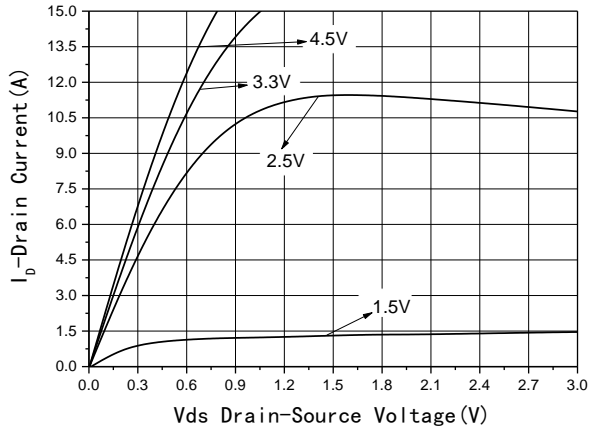

Fig1 Output Characteristics

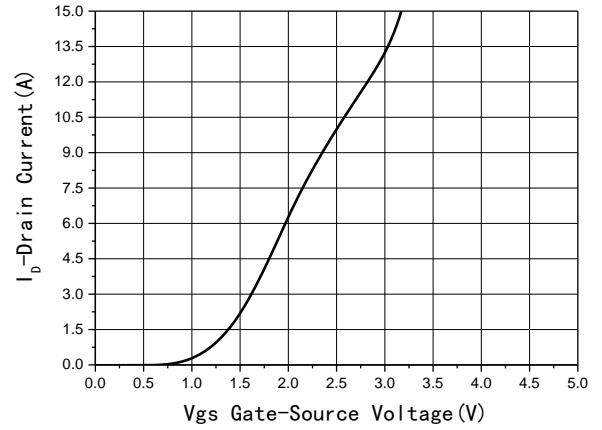

Fig2 Transfer Characteristics

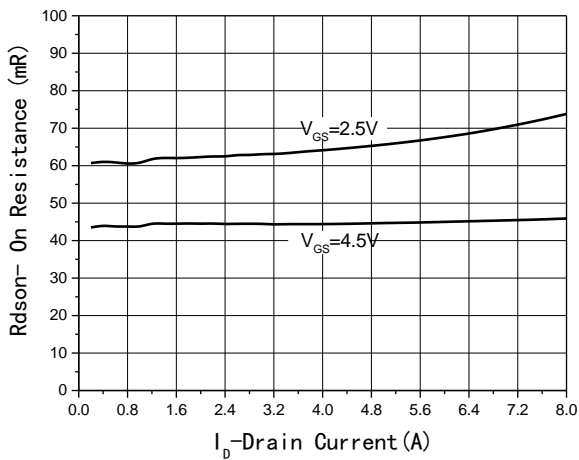

Fig3 $R_{DS(on)}$ -Drain current

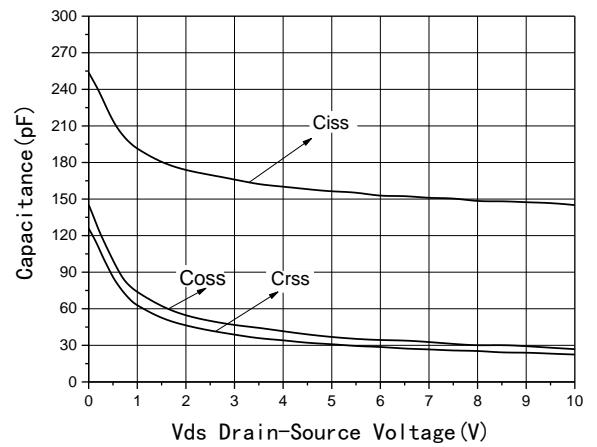

Fig4 Capacitance vs V_{DS}

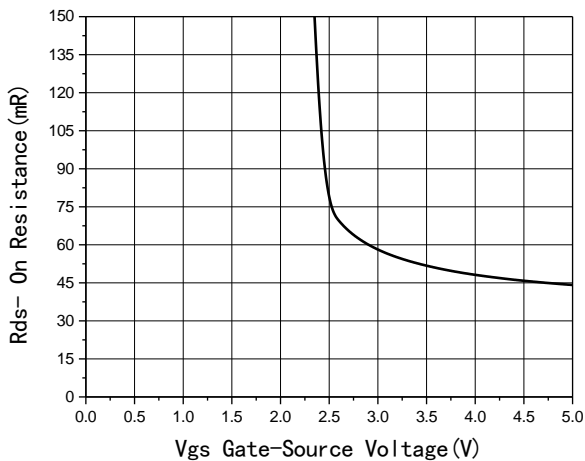

Fig5 $R_{DS(on)}$ -Gate Drain voltage

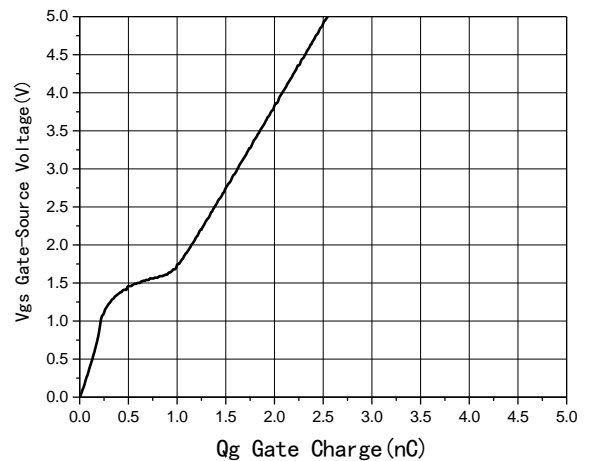

Fig6 Gate Charge

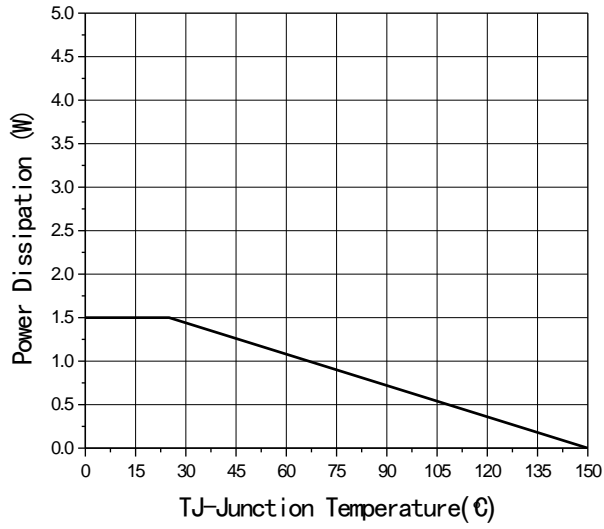

Fig7 Power De-rating

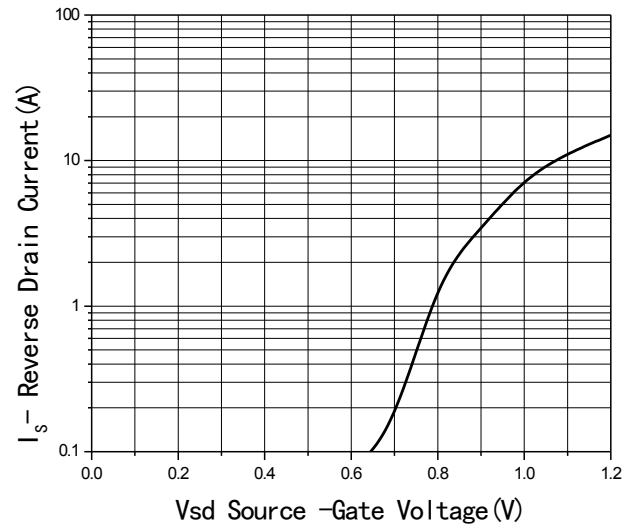
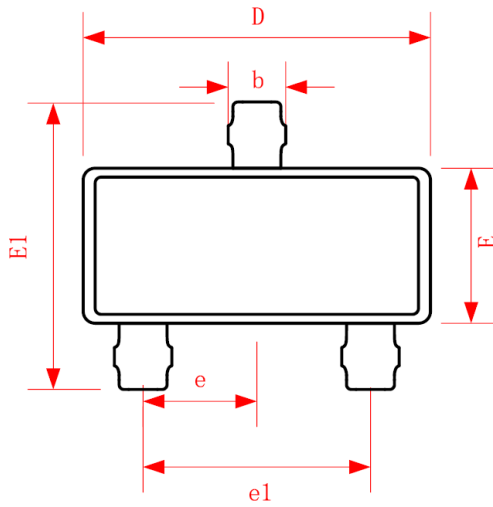

Fig8 Source-Drain Diode Forward

Package Information

- ESOT-23-3L



Top View
【顶视图】

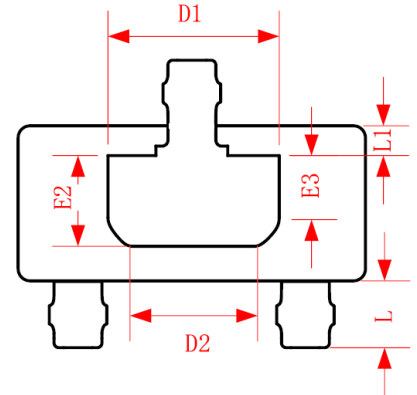

Bottom View
【背视图】

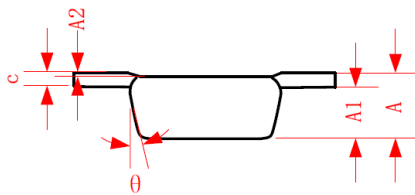

Side View
【侧视图】

Symbol	Dimensions In Millimeters		
	Min.	REF.	Max.
A	0.500	0.550	0.600
A1	0.368	0.398	0.428
A2	-0.030	0.000	0.030
c	0.152Ref		
D	2.850	2.900	2.950
E	1.250	1.300	1.350
E1	2.350	2.400	2.450
D1	1.405	1.430	1.455
D2	0.995	1.020	1.045
E2	0.735	0.760	0.785
E3	0.490	0.520	0.545
L	0.525	0.550	0.575
L1	0.235	0.260	0.285
e	0.950Ref		
e1	1.800	1.900	2.000
b	0.410	0.480	0.550
θ	14°	15°	16°