

30V P-Channel Enhancement Mode MOSFET

Description

The NP3407MR uses advanced trench technology to provide excellent $R_{DS(ON)}$, low gate charge and operation with gate voltages as low as 2.5V. This device is suitable for use as a load switch or in PWM applications.

General Features

- ◆ $V_{DS} = -30V$, $I_D = -4A$
 $R_{DS(ON)}(Typ.) = 61m\Omega$ @ $V_{GS} = -4.5V$
 $R_{DS(ON)}(Typ.) = 48m\Omega$ @ $V_{GS} = -10V$
- ◆ High power and current handling capability
- ◆ Lead free product is acquired
- ◆ Surface mount package

Application

- ◆ PWM applications
- ◆ Load switch

Package

- ◆ SOT-23-3L



Schematic diagram

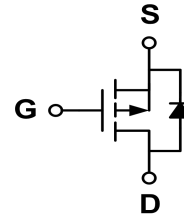

Marking and pin assignment

SOT-23-3L
(TOP VIEW)

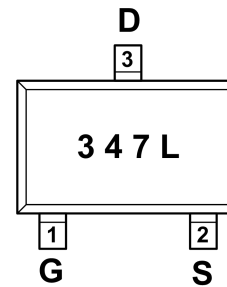

347—NP3407

L—Package Information

Ordering Information

Part Number	Storage Temperature	Package	Devices Per Reel
NP3407MR-G	-55°C to +150°C	SOT-23-3L	3000

Absolute Maximum Ratings (TA=25°C unless otherwise noted)

parameter	symbol	limit	unit	
Drain-source voltage	V_{DS}	-30	V	
Gate-source voltage	V_{GS}	±20	V	
Continuous Drain Current	I_D	TC=25°C	-4	A
		TC=70°C	-3.0	
Pulsed Drain Current ^C	I_{DP}	-16	A	
power dissipation ^B	P_D	TC=25°C	1.4	W
		TC=70°C	0.9	
Junction and Storage Temperature Range	T_J, T_{SGT}	-55—150	°C	

Electrical Characteristics (TA=25°C unless otherwise noted)

Parameter	Symbol	Condition	Min	Typ	Max	Unit
OFF Characteristics						
Drain-source breakdown voltage	BV _{DSS}	V _{GS} =0V, I _D =-250μA	-30	-	-	V
Zero gate voltage drain current	I _{DSS}	V _{DS} =-30V, V _{GS} =0V	-	-	-1	μA
Gate-body leakage	I _{GSS}	V _{DS} =0V, V _{GS} =±20V	-	-	±100	nA
ON Characteristics						
Gate threshold voltage	V _{GS(th)}	V _{DS} =V _{GS} , I _D =-250μA	-0.9	-1.3	-2	V
Drain-source on-state resistance	R _{DS(ON)}	V _{GS} =-10V, I _D =-4A	-	48	60	mΩ
		V _{GS} =-4.5V, I _D =-3A	-	61	85	
Forward transconductance	G _{FS}	V _{DS} =-5V, I _D =-4A	-	5	-	S
Dynamic Characteristics						
Input capacitance	C _{ISS}	V _{DS} =-15V, V _{GS} =0V f=1.0MHz	-	600	-	pF
Output capacitance	C _{OSS}		-	85	-	
Reverse transfer capacitance	C _{RSS}		-	65	-	
Gate resistance	R _g	V _{DS} =15mV, f=1.0MHz		10		Ω
Switching Characteristics						
Turn-on delay time	t _{D(ON)}	V _{DS} =-15V I _D =-4A V _{GEN} =-10V R _L =10ohm R _{GEN} =6ohm	-	3.0	3.5	ns
Rise time	t _r		-	31	35	
Turn-off delay time	t _{D(OFF)}		-	33	40	
Fall time	t _f		-	8	12	
Total gate charge	Q _g	V _{DS} =-15V, I _D =-4A V _{GS} =-4.5V	-	6.2	-	nC
Gate-source charge	Q _{gs}		-	1.7	-	
Gate-drain charge	Q _{gd}		-	2.5	-	
Body Diode Reverse Recovery Time	t _{rr}	IF=-4A, dI/dt=100A/ms		24		nS
Body Diode Reverse Recovery Charge	Q _{rr}	IF=-4A, dI/dt=100A/ms		1.8		nC
DRAIN-SOURCE DIODE CHARACTERISTICS						
Diode forward voltage	V _{SD}	V _{GS} =0V, I _S =-4.2A	-	-0.81	-1.2	V

Thermal Characteristics

Parameter	Symbol	Typ.	Max.	Unit
Maximum Junction-to-Ambient ^A	R _{θJA}	70	90	°C/W
Maximum Junction-to-Ambient ^{A D}		Steady-State	100	
Maximum Junction-to-Lead	R _{θJL}	62	80	

A. The value of R_{θJA} is measured with the device mounted on 1in² FR-4 board with 2oz. Copper, in a still air environment with T_A=25°C. The value in any given application depends on the user's specific board design.

B. The power dissipation PD is based on T_{J(MAX)}=150°C, using ≤ 10s junction-to-ambient thermal resistance.

C. Repetitive rating, pulse width limited by junction temperature T_{J(MAX)}=150°C. Ratings are based on low frequency and duty

cycles to keep initial $T_J=25^{\circ}\text{C}$.

D. The $R_{\theta JA}$ is the sum of the thermal impedance from junction to lead $R_{\theta JL}$ and lead to ambient.

Typical Performance Characteristics

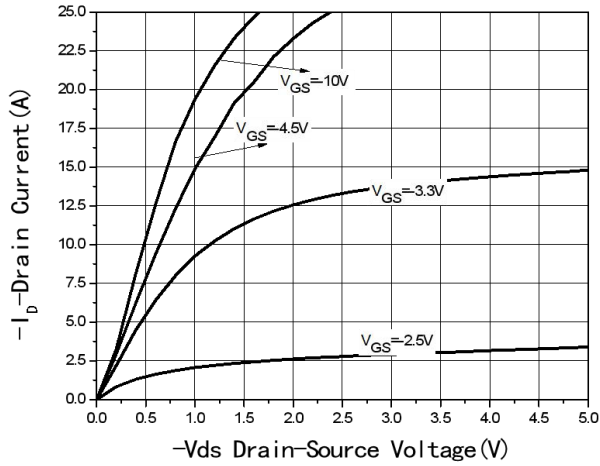

Fig1 Output Characteristics

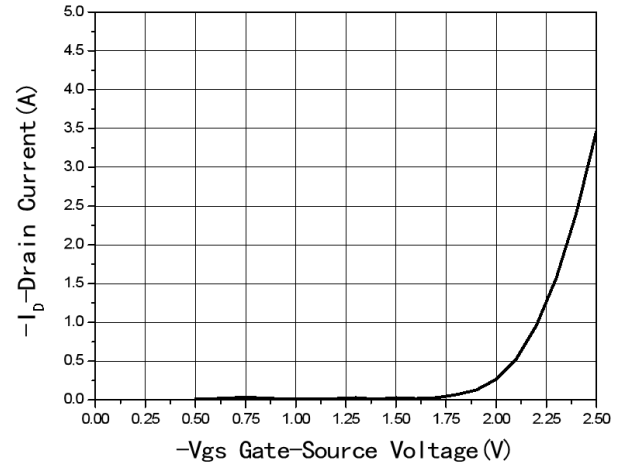

Fig2 Transfer Characteristics

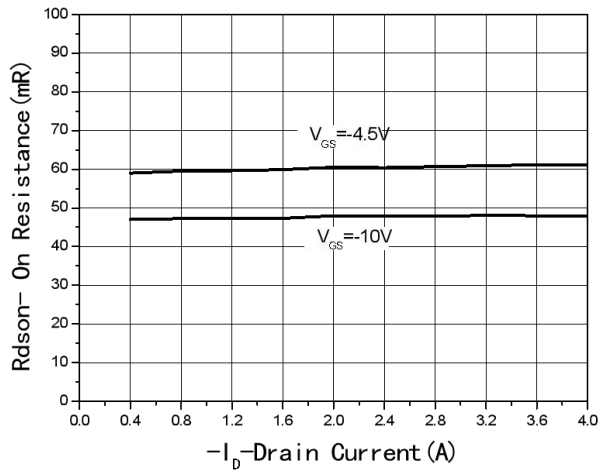

Fig3 Rds-On Drain current

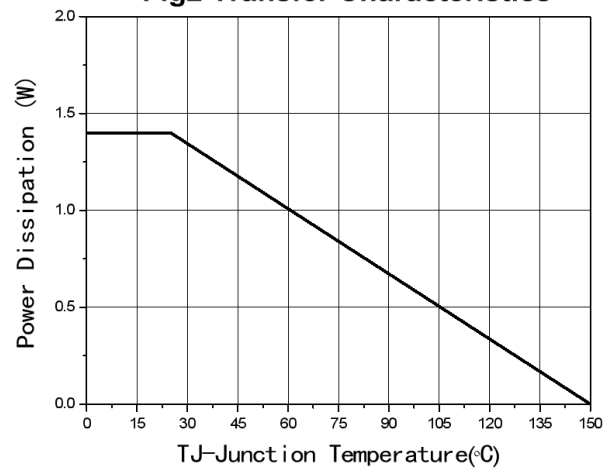

Fig8 Power De-rating

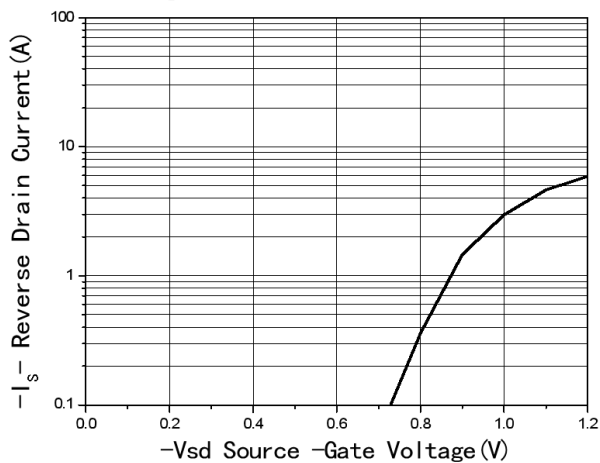

Fig5 Source-Drain Diode Forward

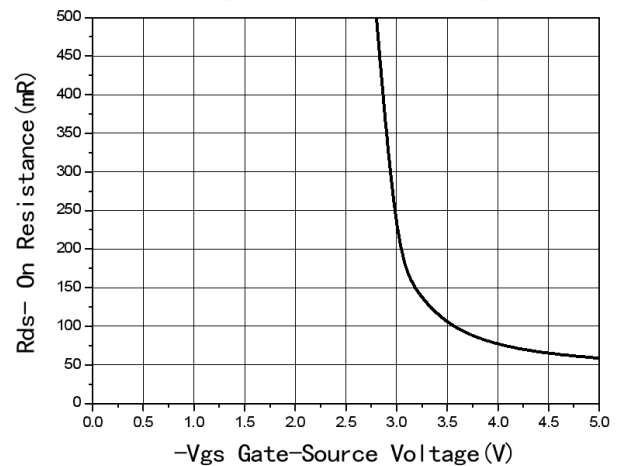
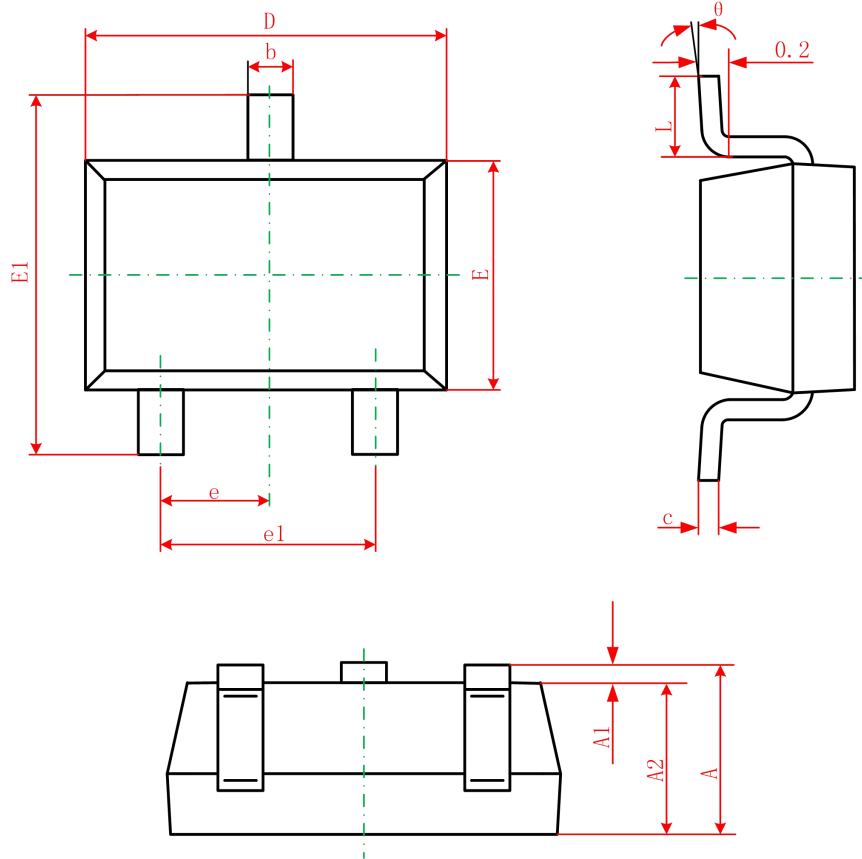

Fig7 Rds-On-Gate Drain voltage

Package Information

- SOT-23-3L



Symbol	Dimensions In Millimeters		Dimensions In Inches	
	Min	Max	Min	Max
A	1.050	1.250	0.041	0.049
A1	0.000	0.100	0.000	0.004
A2	1.050	1.150	0.041	0.045
b	0.300	0.500	0.012	0.020
c	0.100	0.200	0.004	0.008
D	2.820	3.020	0.111	0.119
E	1.500	1.700	0.059	0.067
E1	2.650	2.950	0.104	0.116
e	0.950(BSC)		0.037(BSC)	
e1	1.800	2.000	0.071	0.079
L	0.300	0.600	0.012	0.024
θ	0°	8°	0°	8°